



## **Iседio ArmourJoint Adjustable** Floor jointing solutions for industrial floors



# **We are one team.** **We are Leviat.**

Leviat is the new name of CRH's construction accessories companies worldwide.

Under the Leviat brand, we have united the expertise, skills and resources of Isedio and its sister companies to create a world leader in fixing, connecting and anchoring technology.

The products you know and trust will remain an integral part of Leviat's comprehensive brand and product portfolio. As Leviat, we can offer you an extended range of specialist products and services, greater technical expertise, a larger and more agile supply chain and better, faster innovation.

By bringing together CRH's construction accessories family as one global organisation, we are better equipped to meet the needs of our customers, and the demands of construction projects, of any scale, anywhere in the world.

**This is an exciting change. Join us on our journey.**

**Read more about Leviat at [Leviat.com](https://www.leviat.com)**



Our product brands include:

**Ancon**

**HALFEN**

**HELIFIX**

**ISEDIO**

**PLAKA**



**60**

locations

sales in

**30+**

countries

**3000**

people worldwide

Imagine. Model. Make.

[Leviat.com](https://Leviat.com)

## Isedio ArmourJoint Adjustable

Isedio ArmourJoint Adjustable is an arris protection, load transfer and leave-in-place formwork joint system suitable for heavy duty industrial concrete floors.

The joint system comprises two top strips, an upper divider plate, a lower divider plate, load transfer plate dowels and sleeves. The lower divider plate is attached to the upper divider plate by a special fastener that requires no tools for adjustment. This innovation is protected by a patent.

The joint is designed such that, once cast, the two slab panels either side of the joint begin to shrink independently. One panel includes the dowel sleeve and one of the top strips. The other top strip, the divider plate and the dowel are included in the other part of the slab. The dowel bridges the joint and is embedded in both slab panels.

Formwork for casting a concrete slab is achieved by the vertical divider plates, which supports the top strip edge protection and load transfer plate dowels.

Slab arris protection is provided by way of cold drawn steel top strips with shear studs that anchor the top strips in the concrete.

The special Isedio stud welding machine tests the quality of stud welds one by one to ensure the relevant specifications are met.

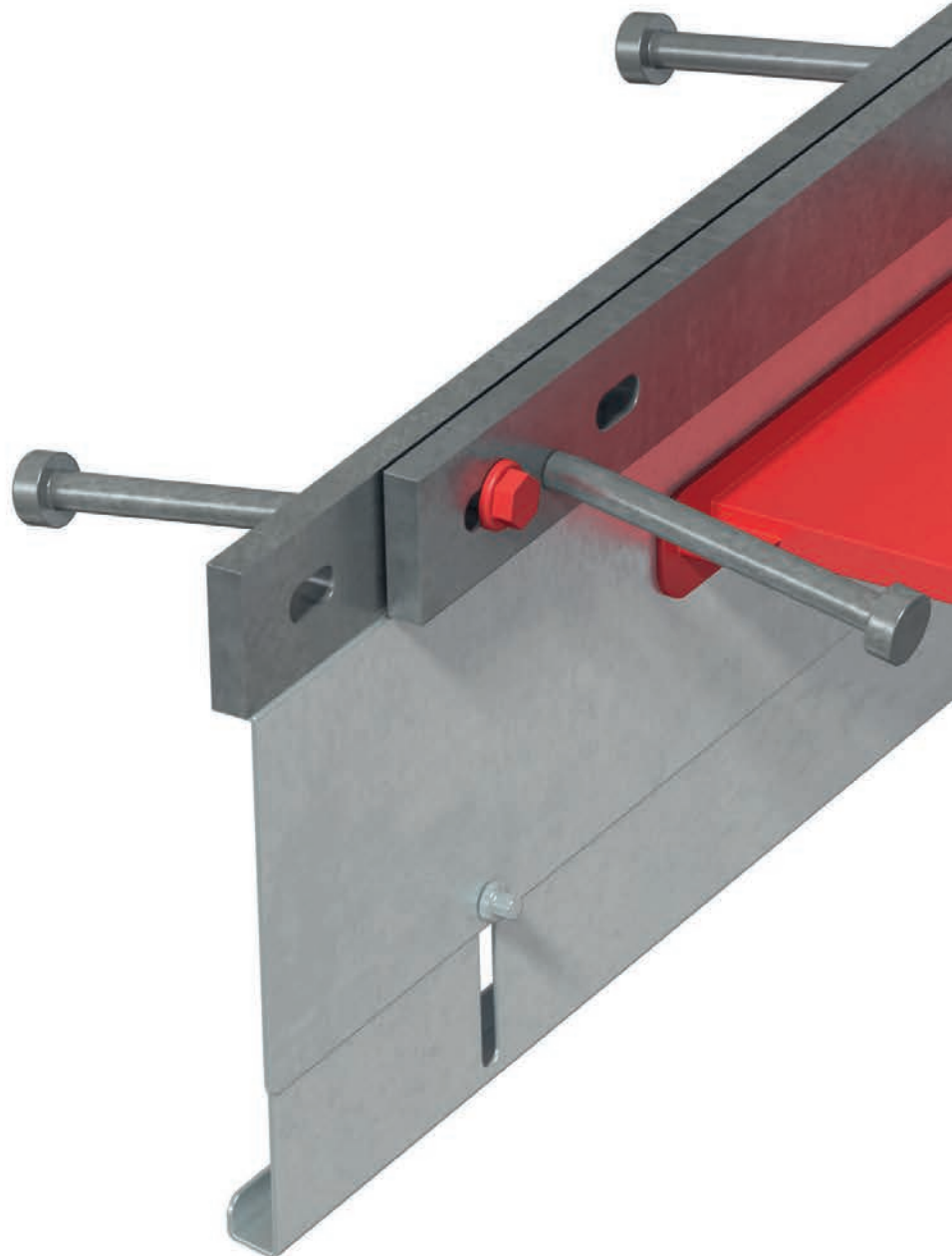



Load transfer across the joint is achieved by asymmetric plate dowels and sleeves. The plate dowels are attached to the vertical divider plate and the sleeves are held in place under friction. The sleeves allow movement as the joint expands and contracts.

ArmourJoint Adjustable allows for a maximum 30mm joint opening and 20mm lateral movement. For any joint opening of more than 15mm, the dowel bending failure should be investigated by the design engineer. Please refer to page 9 for more detailed information.



Easy Installation



Based on TR34.4



Load Transfer Through Plate Dowels



Arris Protection



Engineering Support



Safe Installation



Minimise Joint Maintenance Costs

# Isedio ArmourJoint Adjustable

## Material Specification

Component	Material
Top Strips	Cold drawn steel to BS EN 10277-2:2008 (can be supplied in stainless steel or hot-dip galvanised)
Frangible Fastener	Nylon
Load Transfer Plate Dowel	6mm, 8mm & 12mm - S275 & S355 Steel to BS EN 10025-2:2004
Sleeve	6mm, 8mm & 12mm - PP
Lateral Movement Allowance	20mm in each direction

## Dimensions

Description	Dimension & Tolerance
Joint Length	3000mm, +/-2.0mm
Straightness	+/-1mm in 1000mm
General Dimensional Tolerance	Dimensions < 12mm +/- 0.5mm Dimensions > 12mm +/- 2.0mm

## ArmourJoint Fixed

ArmourJoint Fixed utilises a fixed height divider plate to suit the required slab thickness. Standard ArmourJoint Fixed is available in joint heights from 130mm to 190mm with 10mm increments. Alternatively, it can be manufactured to order in other heights to meet individual project specifications. Contact the Leviat technical team for more information.

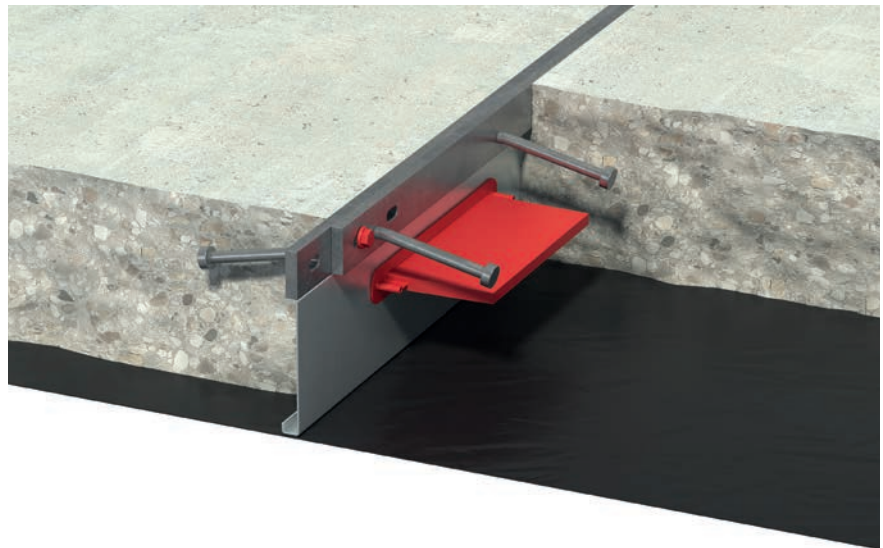

## Packaging Information

5 x 6mm Dowels (600mm centres)			
Joint (mm)	Quantity and metres of joint per bundle	Approx. bundle weight inc. packaging (kg)	Max. no. of bundles, weight and metres per truck
100 - 130mm	50 off - 150m	1,673kg	15 Bundles - 23,417kg - 2,250m
130 - 150mm	49 off - 147m	1,723kg	13 Bundles - 22,404kg - 1,911m
150 - 200mm	49 off - 147m	1,758kg	13 Bundles - 22,854kg - 1,911m
200 - 250mm	35 off - 105m	1,359kg	16 Bundles - 21,739kg - 1,680m
250 - 300mm	28 off - 84m	1,243kg	15 Bundles - 18,650kg - 1,260m
300 - 350mm	21 off - 63m	1,018kg	16 Bundles - 16,287kg - 1,008m

5 x 8mm Dowels (600mm centres)			
Joint (mm)	Quantity and metres of joint per bundle	Approx. bundle weight inc. packaging (kg)	Max. no. of bundles, weight and metres per truck
100 - 130mm	50 off - 150m	1,760kg	13 Bundles - 22,877kg - 1,950m
130 - 150mm	49 off - 147m	1,809kg	13 Bundles - 23,515kg - 1,911m
150 - 200mm	49 off - 147m	1,843kg	13 Bundles - 23,965kg - 1,911m
200 - 250mm	35 off - 105m	1,420kg	16 Bundles - 22,715kg - 1,680m
250 - 300mm	28 off - 84m	1,292kg	15 Bundles - 19,238kg - 1,260m
300 - 350mm	21 off - 63m	1,055kg	16 Bundles - 16,873kg - 1,344m

5 x 12mm Dowels (600mm centres)			
Joint (mm)	Quantity and metres of joint per bundle	Approx. bundle weight inc. packaging (kg)	Max. no. of bundles, weight and metres per truck
100 - 130mm	50 off - 150m	1,548kg	15 Bundles - 23,326kg - 1,800m
130 - 150mm	49 off - 147m	1,681kg	14 Bundles - 23,833kg - 1,764m
150 - 200mm	49 off - 147m	1,719kg	13 Bundles - 22,712kg - 1,638m
200 - 250mm	35 off - 105m	1,793kg	15 Bundles - 23,125kg - 1,575m
250 - 300mm	28 off - 84m	1,673kg	14 Bundles - 19,456kg - 1,176m
300 - 350mm	21 off - 63m	1,128kg	16 Bundles - 18,044kg - 1,008m

# Isedio ArmourJoint Adjustable

## Load Transfer Capacities

The use of Isedio ArmourJoint ensures that shear loads are safely transferred across the joint through dowels. We recommend referring to TR34 – Fourth Edition – Concrete Industrial Ground Floors to determine the dowel capacity.

Section 6.5 of TR34 provides guidance on the calculation of dowel capacities for the following failure modes.

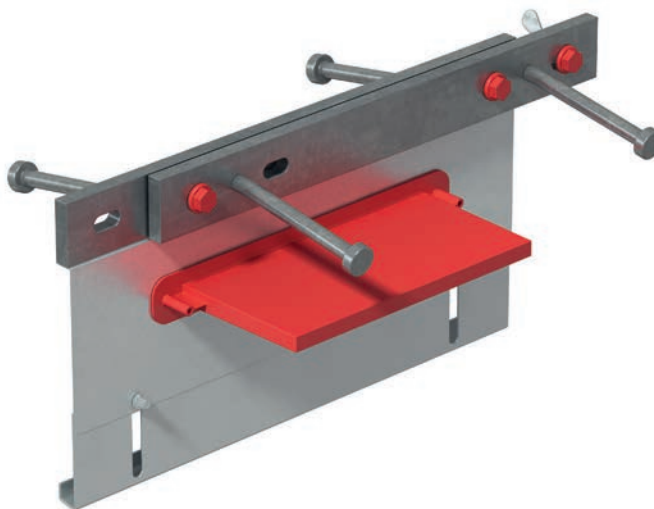

## Dowel Shear Capacity

The shear capacities for the plate dowels provided in the table below have been calculated using equation 18 of TR34.

Dowel Type	Thickness (t) (mm)	Finish*	Shear Area (0.9xA) (mm <sup>2</sup> )	Capacity (P <sub>sh plate</sub> ) (kN)
150 x 150 x 6	6	Black	810	116.2
150 x 150 x 8	8	Black	1080	200.0
150 x 150 x 12	12	Black	1620	300.1

\* Dowels are available in HDG and stainless steel up on request.

In most situations, at the point of ultimate load, the concrete would typically fail before the dowel.

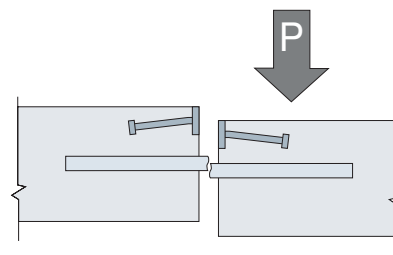

Dowel Shear Capacity

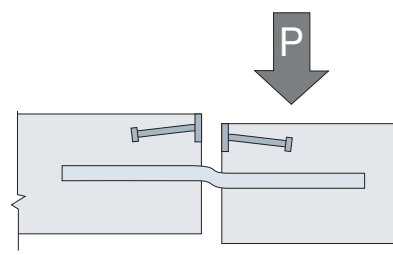

Dowel Bearing/Bending Capacity

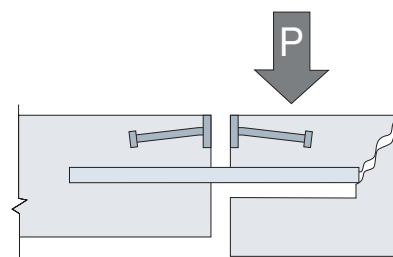

Punching Shear (Bursting Forces)

## Dowel Bearing/Bending Capacity

Bearing/Bending is a combined failure mode that checks the bending capacity of the dowel as well as the bearing capacity of the surrounding concrete. Equation 19 of TR34 defines the bearing/bending capacity of a dowel.

Please find the dowel bearing/bending capacities for different conditions in the combined capacity tables on page 10. For any other configurations, please contact LeviaT.

## Punching Shear (Bursting Forces)

Section 6.5.3 of TR34 recommends calculating the bursting load of the concrete by adapting the EC2 approach for punching failure using an effective depth of 0.75 times the depth between the dowel and the surface of the concrete slab.

Please find the punching shear capacities for different conditions in the combined capacity tables on page 10.



## Design Capacity Tables

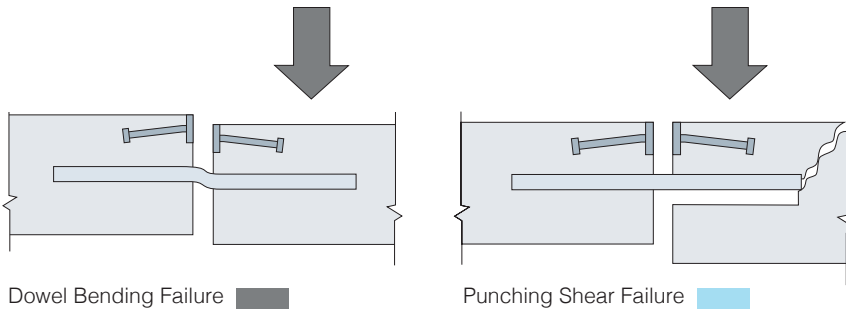

Design shear capacity of Iседio ArmourJoint Adjustable in C32/40 concrete with a dowel spacing of 600mm (kN/m)

Dowel Size mm	Joint Opening mm	Joint Size 100 - 130 Slab Depth (mm)			Joint Size 130 - 150 Slab Depth (mm)		
		100	110	120 - 130	130	140	150
150 x 150 x 6	10	13.0	17.8	19.7	20.5	26.4	28.6
	20	13.0	17.8	19.7	20.5	26.4	28.6
	30	12.9	17.7	19.6	20.4	26.2	28.4
150 x 150 x 8	10	12.5	17.3	19.1	19.9	25.8	27.9
	20	12.5	17.3	19.1	19.9	25.8	27.9
	30	12.4	17.2	19.1	19.9	25.6	27.7

Dowel Size mm	Joint Opening mm	Joint Size 150 - 200 Slab Depth (mm)			Joint Size 200 - 250 Slab Depth (mm)			
		150	160	170 - 200	200	210	220	230 - 250
150 x 150 x 6	10	26.4	32.9	35.3	39.4	47.1	55.5	60.5
	20	26.4	32.9	35.3	39.4	47.1	46.9	46.9
	30	26.2	30.4	33.5	33.5	33.5	33.5	33.5
150 x 150 x 8	10	25.8	32.2	34.6	38.5	46.3	54.6	59.6
	20	25.8	32.2	34.6	38.5	46.3	54.6	59.6
	30	25.6	32.0	34.4	38.4	46.1	54.5	59.3
150 x 150 x 12	10	24.5	30.9	33.2	37.1	44.7	53.0	57.8
	20	24.5	30.9	33.2	37.1	44.7	53.0	57.8
	30	24.4	30.7	33.1	36.9	44.5	52.8	57.5

Dowel Size mm	Joint Opening mm	Joint Size 250 - 300 Slab Depth (mm)				Joint Size 300 - 350 Slab Depth (mm)			
		250	260	270	280 - 300	300	310	320	330 - 350
150 x 150 x 6	10	60.0	69.4	73.7	73.7	73.7	73.7	73.7	73.5
	20	46.9	46.9	46.9	46.9	46.9	46.9	46.9	46.9
	30	33.5	33.5	33.5	33.5	33.5	33.5	33.5	33.5
150 x 150 x 8	10	59.0	68.5	78.5	84.3	83.7	94.7	106.4	113.1
	20	59.0	68.5	78.5	84.3	83.7	94.7	95.2	95.2
	30	58.9	68.2	71.6	71.6	71.6	71.6	71.6	71.6
150 x 150 x 12	10	57.2	66.5	76.5	82.2	81.7	92.5	104.0	110.6
	20	60.8	66.5	76.5	82.2	81.7	92.5	104.0	110.6
	30	57.1	66.3	76.2	81.8	81.3	92.1	103.8	110.3

**Note:** For any other configurations and for Iседio ArmourJoint Fixed capacities, please contact the Leviat technical team on 01458 270 600 or email [info.isedio.uk@leviat.com](mailto:info.isedio.uk@leviat.com).

# Isedio ArmourJoint Adjustable

## Installation



1 Set up the site. Laser dumpy level set up, finished floor level datum taken, membrane laid, hand tools available

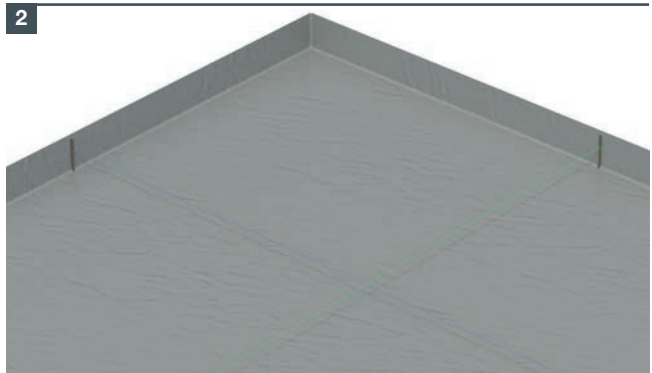

2 Measure the distances to the walls and edges. Set up the string line following the joint location.

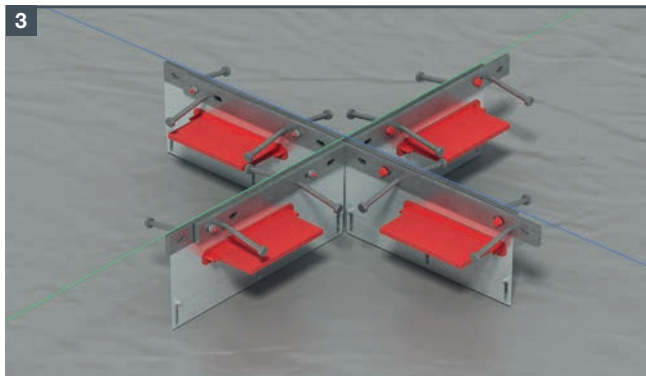

3 If required, place the intersection (4-way, 3-way or corner).

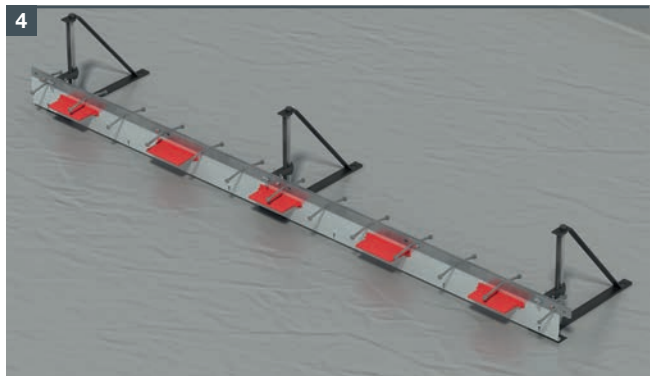

4 Fit ArmourJacks to the ArmourJoint top strips.

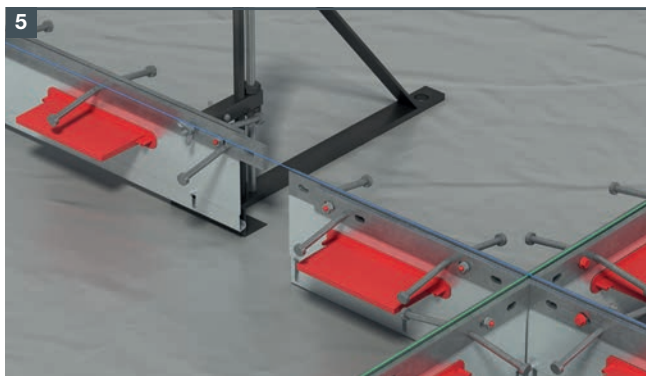

5 Position the ArmourJoints (with the jacks fitted) and attach them to the intersection.



6 Continue to fit the ArmourJoints. Ensure the lapped joints are butted end to end tightly. Fit the plastic bolt and wing nut at the lapped joint.

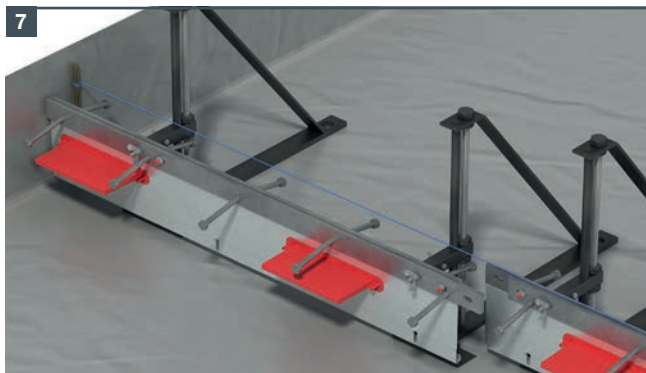

7 Measure final distance and cut ArmourJoint to suit, allow space for midthene between end joint and wall.



8 Manually position ArmourJoints in line with string lines.

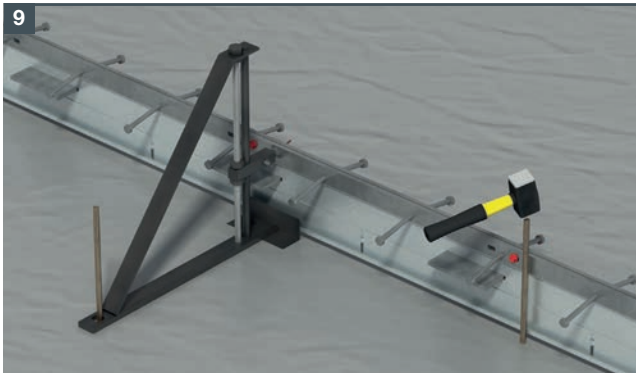

9 Pin the ArmourJacks into place and drive the pins behind the ArmourJoint in between the jacks.



Scan the QR code or visit our website to watch the installation video.

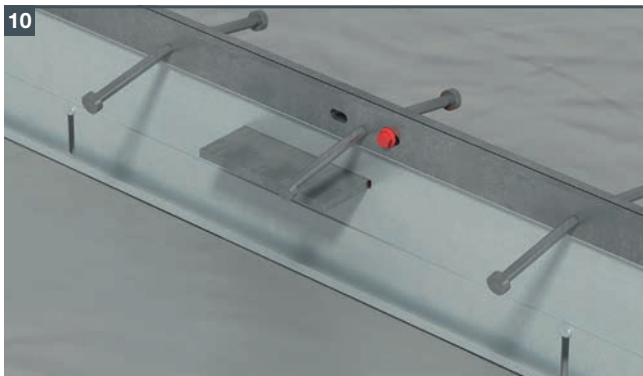

10 Ensure the lower divider plate is pushed fully down to sub-base.

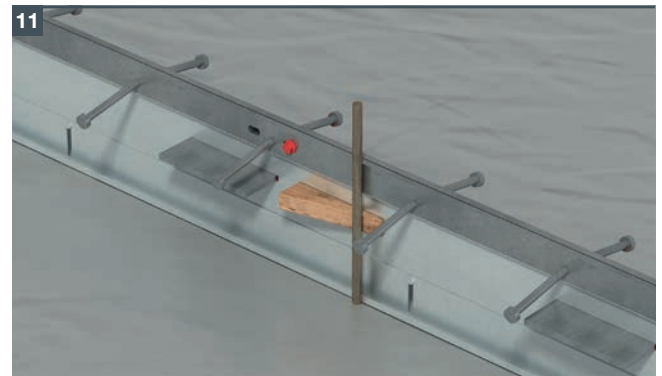

11 Fit the wooden wedges behind the pin to lock the joint in place.

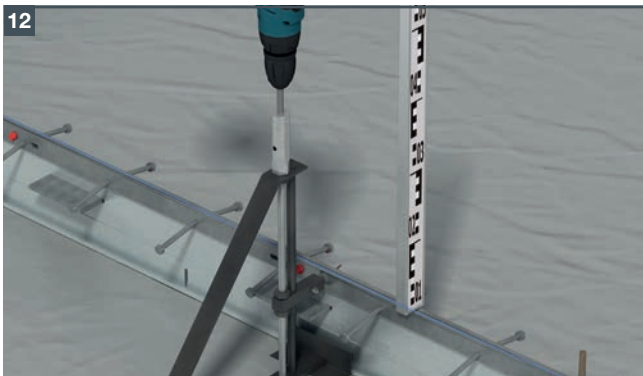

12 Check the height and adjust where necessary using the nut on the jack.

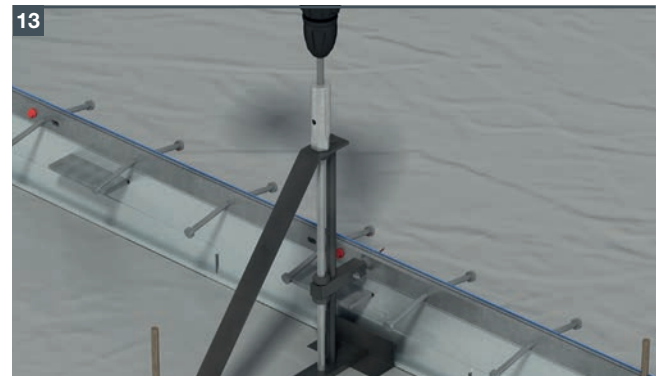

13 Final visual inspection, adjust the position and height of the joint if required.



14 Pour the concrete while checking the height and position of the joint.

# Isedio Accessories

## Prefabricated Intersections

Corner, 3-way and 4-way intersections are available to simplify installation. These components will be manufactured with the same height and plate dowel specifications to suit ArmourJoint Adjustable and ArmourJoint Fixed.

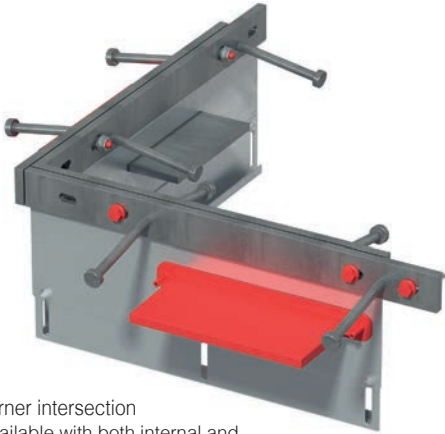

Corner intersection  
(available with both internal and external sleeve orientation)

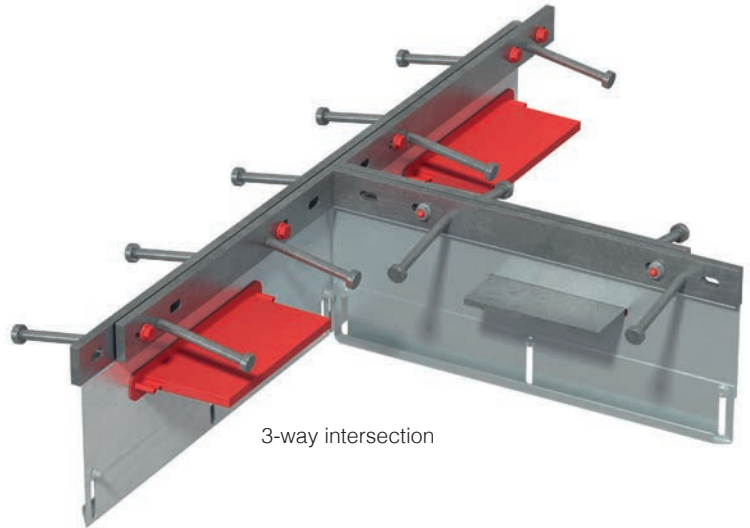

3-way intersection

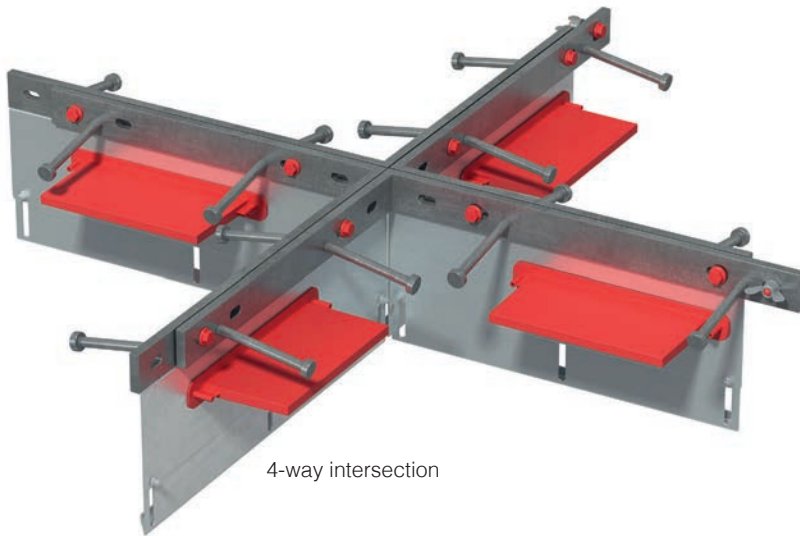

4-way intersection

## Installation Jacks

Installation Jacks are reusable items that facilitate speedy and accurate installation of ArmourJoint. Use of installation jacks eliminates the risks associated with the conventional 'pin and weld' method, in particular the risk of cracking posed by the pins restraining movement at the joint opening.



# Isedio Product Range

## ShieldJoint

ShieldJoint is an innovative, leave-in-place joint system designed specifically to meet the demanding needs of today's industrial concrete floors. ShieldJoint is a zero impact, sealant-free joint system.

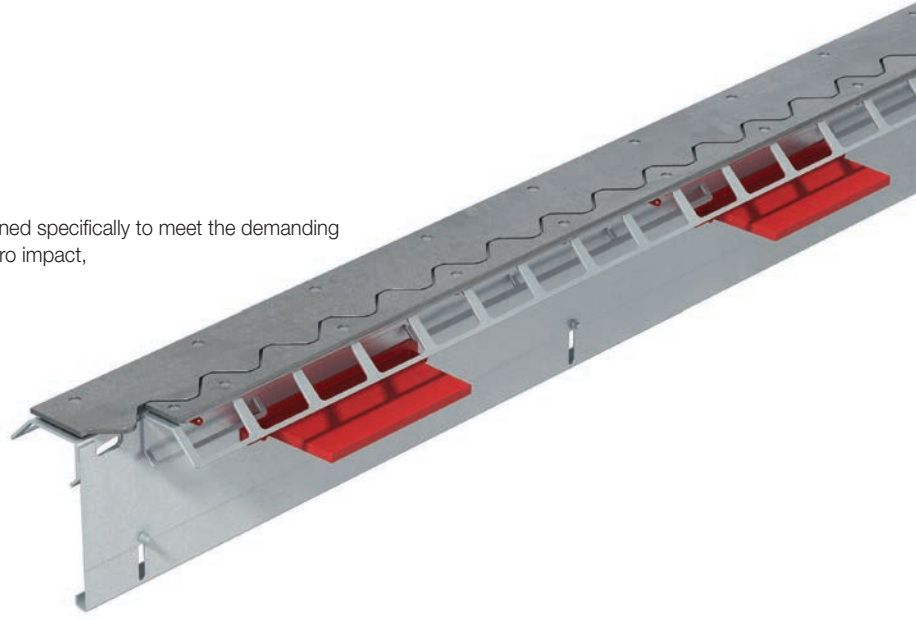

## ArmourJoint-Lite

ArmourJoint-Lite is another variation of the ArmourJoint family suitable for light duty industrial concrete floors that are traversed by pneumatic wheeled equipment.



## GuardJoint Adjustable

GuardJoint Adjustable eliminates impact across the joint from Mechanical Handling Equipment (MHE). The shape of the wave is engineered such that even the smallest pallet wheeled trucks do not cause an impact.



## SteelDeckJoint

SteelDeckJoint is a revolutionary floor joint solution, which solves many of the complexities and time consuming elements of more traditional methods of forming a construction joint using timber formwork.

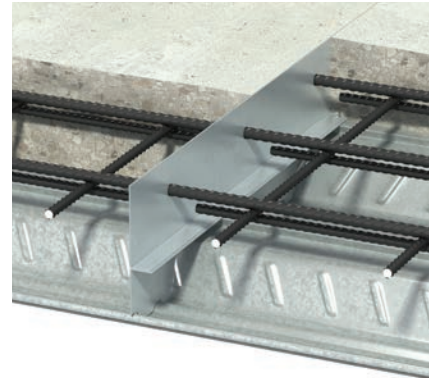

## ExpaJoint

ExpaJoint is a leave-in-place formwork, load transfer and edge protection joint system suitable for external concrete pavements and yards.



## ShieldJoint Arris Repair

ShieldJoint Arris Repair is specifically designed for the repair of construction joints where the concrete either side of the joint has become damaged through traffic impact.

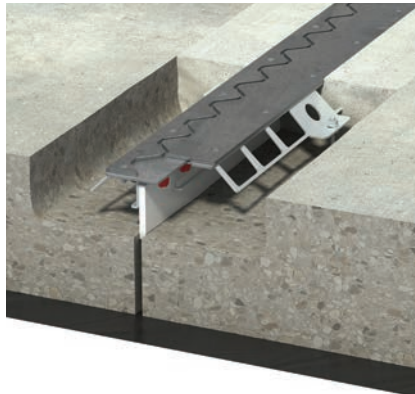

## Armourstrip Double

Armourstrip Double is an edge protection system suitable for heavy duty industrial concrete floors and is compatible with timber formwork.





**Leviat<sup>®</sup>**  
A CRH COMPANY

Innovative engineered products and construction solutions that allow the industry to build safer, stronger and faster.



## Worldwide contacts for Leviat:

### Australia

Leviat  
98 Kurrajong Avenue,  
Mount Druitt Sydney, NSW 2770  
Tel: +61 - 2 8808 3100  
Email: info.au@leviat.com

### Austria

Leviat  
Leonard-Bernstein-Str. 10  
Saturn Tower, 1220 Wien  
Tel: +43 - 1 - 259 6770  
Email: info.at@leviat.com

### Belgium

Leviat  
Industrielaan 2  
1740 Ternat  
Tel: +32 - 2 - 582 29 45  
Email: info.be@leviat.com

### China

Leviat  
Room 601 Tower D, Vantone Centre  
No. A6 Chao Yang Men Wai Street  
Chaoyang District  
Beijing · P.R. China 100020  
Tel: +86 - 10 5907 3200  
Email: info.cn@leviat.com

### Czech Republic

Leviat  
Business Center Šafránková  
Šafránková 1238/1  
155 00 Praha 5  
Tel: +420 - 311 - 690 060  
Email: info.cz@leviat.com

### Finland

Leviat  
Vädursgatan 5  
412 50 Göteborg / Sweden  
Tel: +358 (0)10 6338781  
Email: info.fi@leviat.com

### France

Leviat  
6, Rue de Cabanis  
FR 31240 L'Union  
Toulouse  
Tel: +33 - 5 - 34 25 54 82  
Email: info.fr@leviat.com

### Germany

Leviat  
Liebigstrasse 14  
40764 Langenfeld  
Tel: +49 - 2173 - 970 - 0  
Email: info.de@leviat.com

### India

Leviat  
309, 3rd Floor, Orion Business Park  
Ghodbunder Road, Kapurbawdi,  
Thane West, Thane,  
Maharashtra 400607  
Tel: +91 - 22 2589 2032  
Email: info.in@leviat.com

### Italy

Leviat  
Via F.lli Bronzetti 28  
24124 Bergamo  
Tel: +39 - 035 - 0760711  
Email: info.it@leviat.com

### Malaysia

Leviat  
28 Jalan Anggerik Mokara 31/59  
Kota Kemuning, 40460 Shah Alam  
Selangor  
Tel: +603 - 5122 4182  
Email: info.my@leviat.com

### Netherlands

Leviat  
Oostermaat 3  
7623 CS Borne  
Tel: +31 - 74 - 267 14 49  
Email: info.nl@leviat.com

### New Zealand

Leviat  
2/19 Nuttall Drive, Hillsborough,  
Christchurch 8022  
Tel: +64 - 3 376 5205  
Email: info.nz@leviat.com

### Norway

Leviat  
Vestre Svanholmen 5  
4313 Sandnes  
Tel: +47 - 51 82 34 00  
Email: info.no@leviat.com

### Philippines

Leviat  
2933 Regus, Joy Nostalg,  
ADB Avenue  
Ortigas Center  
Pasig City  
Tel: +63 - 2 7957 6381  
Email: info.ph@leviat.com

### Poland

Leviat  
Ul. Obornicka 287  
60-691 Poznań  
Tel: +48 - 61 - 622 14 14  
Email: info.pl@leviat.com

### Singapore

Leviat  
14 Benoi Crescent  
Singapore 629977  
Tel: +65 - 6266 6802  
Email: info.sg@leviat.com

### Spain

Leviat  
Polígono Industrial Santa Ana  
c/ Ignacio Zuloaga, 20  
28522 Rivas-Vaciamadrid  
Tel: +34 - 91 632 18 40  
Email: info.es@leviat.com

### Sweden

Leviat  
Vädursgatan 5  
412 50 Göteborg  
Tel: +46 - 31 - 98 58 00  
Email: info.se@leviat.com

### Switzerland

Leviat  
Grenzstrasse 24  
3250 Lyss  
Tel: +41 - 31 750 3030  
Email: info.ch@leviat.com

### United Arab Emirates

Leviat  
RA08 TB02, PO Box 17225  
JAFZA, Jebel Ali, Dubai  
Tel: +971 (0)4 883 4346  
Email: info.ae@leviat.com

### United Kingdom

Leviat  
President Way, President Park,  
Sheffield, S4 7UR  
Tel: +44 - 114 275 5224  
Email: info.uk@leviat.com

### United States of America

Leviat  
6467 S Falkenburg Rd.  
Riverview, FL 33578  
Tel: (800) 423-9140  
Email: info.us@leviat.us

### For countries not listed

Email: info@leviat.com

**Leviat.com**

#### Notes regarding this catalogue

© Protected by copyright. The construction applications and details provided in this publication are indicative only. In every case, project working details should be entrusted to appropriately qualified and experienced persons. Whilst every care has been exercised in the preparation of this publication to ensure that any advice, recommendations or information is accurate, no liability or responsibility of any kind is accepted by Leviat for inaccuracies or printing errors. Technical and design changes are reserved. With a policy of continuous product development, Leviat reserves the right to modify product design and specification at any time.



For more information on these products, contact:

**Leviat**

Unit 10 Jubilee Park  
Badger's Cross Lane  
Somerton  
Somerset, TA11 7JF  
United Kingdom

Tel: +44 (0) 1458 270 600

Email: [info.isedio.uk@leviat.com](mailto:info.isedio.uk@leviat.com)

[isedio.com](http://isedio.com)

[Leviat.com](http://Leviat.com)

**Imagine. Model. Make.**

**[Leviat.com](http://Leviat.com)**